



Orona 

**We are
your travel
companion.**

CATALOGUE FOR SOLUTIONS

We are Orona, your best travel companion

You are in good hands, the best hands.

We are Orona, a leading business group in sustainable vertical passenger mobility; every day we help more than 25 million people reach their destinations around the world.

Our objective is to bring people together, shortening the distances that separate them.

A number is worth a thousand words

+30,000

units per year production capacity

No. 1

in complete lift production capacity in Europe

60

years of experience

+300,000

lifts worldwide with Orona technology

A leader in elevation that puts the best of its knowledge at your disposal:

- Extensive experience throughout the entire vertical lift value chain
- The plant with the largest production capacity for complete lifts in Europe
- Lifting solutions designed and manufactured in Europe for the world

A committed partner:

- Social commitment, cooperative: people who work with people. We are united by our values.

Getting closer, our way to be and our way of doing.

JOIN THE...

world leader in the distribution of complete lifts with a presence in more than 100 countries through local partners and long-standing relationships.

A MODEL BASED ON...

comprehensive support, providing its partners with first-class technical assistance.

COLLABORATION IN...

solving the major challenges of the **value chain** through access to processes and applications that provide competitiveness and differentiating features.

COMMITMENT...

in ensuring our partners have access to the latest market trends through our continued **investment in R&D**.

Join the Orona Next Experience, where the journey is the destination, live your own story.



The place where ideas develop..

Orona Ideo is the place where ideas, inspiration and future innovation meet.

Orona Ideo, together with our production plant, embraces the values that underpin Orona's strategy. It's much more than a set of facilities, it is the key to developing and consolidating any idea or project.

Orona Ideo is the ecosystem that brings together all the stakeholders involved in our innovation network, companies, universities and research centres, acting as a driver for increased knowledge and idea sharing which ultimately transforms into results.

...and the place where we make them happen.

Facilities with **the largest production capacity** for complete elevators in Europe.

Orona has two production plants where manufactures equipment and provides service to customers over more than 100 countries in the world.

These production plants are organized in self-managed factories where each of them incorporates its own engineering, procurement logistics, material transformation and quality control..

All the components of the elevator are fully produced in these production plants, ensuring that the whole lift is shipped completely.

This makes us **No. 1 in complete lift production capacity in Europe**, with 30,000 lifts per year.



Orona Next, we elevate your travel experience.

We are living in an increasingly global and digital world, a world in which the physical distance between people can be overcome thanks to technological development, which brings them closer together.

Just imagine having a partner who gives you access, in advance, to disruptive elements that make a difference, who guarantees you an innovative and competitive product, today and tomorrow. A partner who offers you a close involvement at all stages of the process, with comprehensive advice that takes you to the next level.

Orona Next is born, the platform for mobility solutions for people in buildings, which every day fulfils Orona's goal of bringing people together and shortening the distances that separate them. A platform of lift solutions, with a wide range of options to suit your needs.

DESIGNED TO TAKE CARE OF YOU

Solutions that contribute to your well-being on board our lift cars, because our aim is to bring people together and shorten distances, looking after you and your loved ones throughout your trip.

A UNIVERSAL ACCESSIBILITY SPACE

Accessibility elements to ensure that your lift is a universal space, so that it can be used by everyone in safe, comfortable conditions and in the most natural and independent manner.

WE PUT ALL OUR ENERGY AT THE SERVICE OF SUSTAINABILITY

We design and integrate all systems to reduce the energy consumption of your solution, thinking about today and tomorrow, because sustainability is a part of who we are.



Designed to take care of you.

Your health and that of your loved ones is important to us. That's why at Orona we have developed a series of solutions that contribute to your well-being:



Air purifier

The air purifier with nanoe™ X*1) technology inhibits the activity of viruses*2), ensuring that the lift car air is clean and guaranteeing your well-being. It has a highly efficient purifying function.

nanoe™ X technology is based on a multitude of hydroxyl radicals grouped into water droplets that inhibit viruses, transforming their protein.

Furthermore, the high level of air renewal in a lift reduces the risk of exposure. The greater the lift ventilation rate, the lower the accumulated dose to which passengers will potentially be exposed.

* 1) nanoe™ X is a registered trademark of Panasonic Corporation.

* 2) Test results may vary according to the exposure area and air quality. Further information at www.orona-group.com/en-gb/orona-next/

Anti-bacterial car walls

The innovative materials used on the lift surface keep your lift car clean, thanks to the antibacterial surface.

Antimicrobial handrails

The handrail is the element used to facilitate access to the lift car, which is why we protect our handrails with an antimicrobial treatment that prevents both bacteria and viruses.



A space with universal accessibility

Orona Next includes accessibility elements to ensure that your lift is a universal space, so that it can be used by everyone in safe, comfortable conditions and in the most natural and independent manner.

Included features • Accessibility pack



PRECISE STOPPING

Optimises accessibility when entering or exiting the lift.



INDUCTIVE/ACOUSTIC COUPLING

For people with hearing disabilities.



BRaille PUSH BUTTON



CAR PUSH BUTTON

Model with additional contrast.



GONG IN CAR AND ON LANDINGS

Notification of the lift reaching its destination through acoustic and visual signal.



ERGONOMIC HANDRAIL

Heights appropriate for users either standing or in wheelchairs.



MULTILINGUAL VOICE SYNTHESISER

Announces floor level, direction of travel and door operation.



SAFETY MIRROR ON THE BACK WALL

Facilitates detection of obstacles when exiting..



PHOTOELECTRIC CURTAIN

Avoids the risk of the doors hitting, allowing a safer use of the lift.



AUDIBLE AND VISUAL PUSH BUTTON INFORMATION

Their location, design, colour and visual / tactile (Braille) / sound operation comply with the EN 81-70 standard.

Other configurable options

- Tip-up seat.
- Visible direction arrow that displays the lift's direction of travel prior to its departure.
- Rear-view mirror.

Minimum car dimensions

We have cars with dimensions in accordance with EN 81-70.

Consult standard dimensions tables.

All our energy at the service of sustainability.

We have reduced energy consumption by up to 75%.

At Orona, we work responsibly and sustainably throughout the whole value chain, designing environmentally-friendly mobility solutions and promoting the development of a circular economy.



Class AAA solutions for all categories.

As a result of the high energy performance achieved by LED lightning and the standby mode system, **Orona Next** solutions have been granted class AAA energy certification in agreement with VDI/ISO standards.

We were the 1st company in the sector to receive Eco-design certification ISO 14006

Since 2008, the year in which we started to eco-design lifts according to UNE 150301, we have accumulated milestones and experience in eco-efficiency, reflecting our commitment to sustainability.

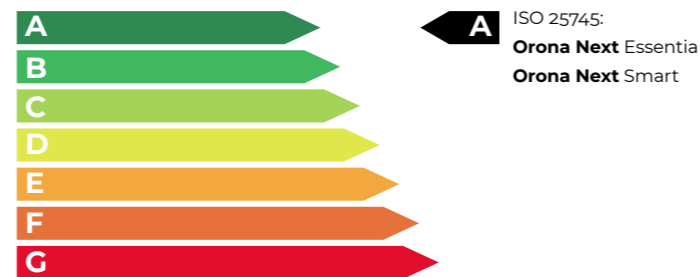

Environmental Product Declaration

Our **Orona Next** models have Environmental Product Declarations (EPD) certified under standard ISO 14025. We make information related to the environmental performance of our products available to you, based on a Life Cycle Analysis (LCA) performed according to the Eco-design standard ISO 14006.

Organisational Carbon Footprint

As part of our commitment to Sustainability, we have Carbon Footprint certification according to ISO 14064, and we exercise transparency in relation to the emission of greenhouse gases resulting from our activity. Thus, we assume the yearly commitment to reduce emissions in our whole value chain.



Alternatives for reducing energy consumption by your lift.

- 1. ORONA GRID REGEN. ENERGY REGENERATION SYSTEM.**
 - Every time the car goes up with a light load or down with a heavy one, instead of consuming it, the lift motor generates energy.
 - The energy generated by the lift can be used by other devices connected to the same network or (depending on the country) returned to the network, reducing consumption and contributing to cost savings.
- 2. GEARLESS LOW-ENERGY DRIVE**
 - Our machine has one of the highest energy efficiencies in the market, reaching 90% performance.
- 3. EFFICIENT LED LIGHTING AND AUTOMATIC CAR LIGHTING SWITCH-OFF**
 - Orona solutions include these two features out of the box, saving up to 80%.
 - Its useful life is up to 10 times longer.
- 4. LIFT STANDBY MODE**

When the lift is on stand-by:

 - Car digital elements and signalling are dimmed.
 - The power elements (frequency inverter) switch to stand-by mode.
 - The car fan switches off.



Be **free**: choose the solution that best meets your needs.



Model	Description of solution groups	Speed	Load Capacity		Maximum travel		Entrances	
			m/s	kg	persons	m	stops	2x180°
Orona Next Essentia	Functionality and comfort within your reach	1	320-400-450-630	4-5-6-8	40	14	○	○
Orona Next Smart	Customised comfort	1-1.6	320 to 1000	4 to 13	50-60	21	○	*
Orona Next Smart+	Quicker, stronger, taller	1-1.6	630 to 2500	8 to 33	50-75	32	○	*
Orona Next Rise	Solutions for high-rise buildings	1.75-2.5	450* to 1600	6* to 21	130	64	○	
Orona Next Flex	Fits in any shaft	1	180 to 630	2 to 8	40	14	○	○

*Consult technical specifications ○ Optional

Essentia Functionality & comfort within your reach.

Our best-selling solution.

General Specifications

Load	320 - 400 - 450 - 630 kg 320 - 450 kg (Single-phase)
Capacity	4 - 5 - 6 - 8 Kg 4 - 6 persons (Single-phase)
Speed	1 m/s / 0.6 m/s (single-phase)
Maximum Travel	40 m / 25 m (single-phase)
Maximum Floors Served	14 Floors
Machine-room Option	Yes
Entrances	1 Front 2 Open through 2 Front & side
Drive System	Regulated gearless (180 stars per hour)
Controller	ARCA III controller, low energy consumption multiprocessor
Door Types	Automatic side-opening Automatic centre-opening
Clear door opening	700 / 800 / 900 mm
Door Height	2,000 / 2,100 mm
Car Dimensions	Standard
Internal Car Height	2,100 / 2,200 mm
Power Supply	Three-phase / Single-phase

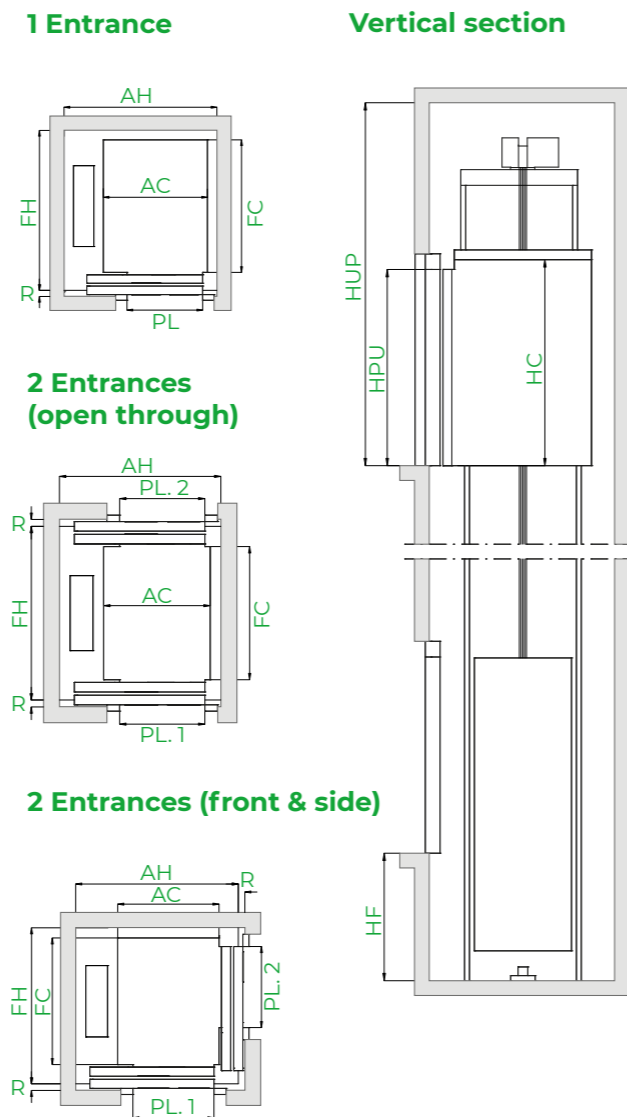

*Note: The diagrams are for guidance only.



Standard dimensions*

Load / Capacity		Car (mm)			Entrances		Lift Shaft ^o (mm)				HF Pit	HUP Head-room
							2-panel side-opening doors		2-panel centre-opening doors			
Persons	Q Load	AC Width	FC Depth	PL Clear opening	Accessibility	No. of entrances	AH ¹ Width	FH ² Depth	AH Width	FH ³ Depth		
							4	320 kg	825	1,100	700	-
2x180°	1,500	1,400										
5	400 kg	850	1,200	800	-	1	1,370	1,450	-	-	3,400	
						2x90°	1,535	1,450	-	-		
6	450 kg	1,000	1,250	800	♿	1	1,500	1,500	1,800	1,450	3,400 (3,000) ⁵⁻⁶	
						2x180°	1,650	1,550	1,550			
		1,000	1,300	800	♿	1	1,550	1,550	1,800	1,500	1,600	3,400 (3,000) ⁵⁻⁶
						2x180°	1,700	1,800	1,600			
8	630 kg	1,100	1,400	900	♿	1	1,600	1,650	2,000	1,600	3,400 (3,000) ⁵	
						2x180°	1,800	1,700	1,700			
		1,200	1,250	900	♿	1	1,700	1,500	2,000	1,450	3,400 (3,000) ⁵	
						2x180°	1,650	2,000	1,550			
-	-	-	-	-	-	1	1,825	1,575	-	-	-	

o Minimum plumb measurements

1 Accessible space below the pit (Counterweight with safety gear) add 50 mm to AH

2 R=60 mm, lift shaft depth with 2-panel side-opening doors, resting 60 mm on the landing

3 R=40 mm, lift shaft depth with 2-panel central-opening doors, resting 40 mm on the landing

4 HF reduced pit optional 850 mm

5 Minimum HUP for internal car height (HC) of 2,100 mm

6 HUP reduced headroom optional only for 6 and 8 persons

7 Not available 2x90° with big doors

*The information is not contractually binding and is subject to the conditions of the shaft



MRL
Machine-room-less solution, with reduced headroom (optional).



Optimised passenger unit
Saves space and reduces weight, providing safety, ergonomics and speed during assembly processes.



Accessible space below the pit
Adapts the lift to suit buildings requiring an accessible space below the pit.

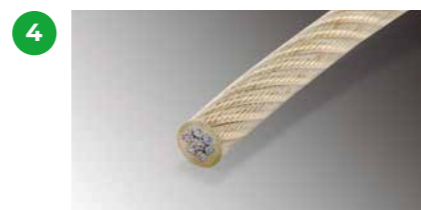

Traction ropes
They replace traditional steel ropes. As a result of their lighter weight, longer lifespan and greater flexibility, it is possible to use a more compact machine.



Drive
Compact, quiet, gearless, energy-efficient, inverter-drive permanent-magnet motor electrical machine.



Doors
With a compact permanent-magnet motor, which allows fast, precise and quiet opening and closing motions, raising current feature standards, with pre-opening and/or light curtain. Optional Solid Door for higher flow situations.



Automatic rescue system
With floor level indication to ensure fast, efficient and safe evacuation of passengers in the event of an emergency. As an option the system can incorporate a fully automatic rescue device to evacuate passengers in the event of a power failure.



Smart Customised comfort

Solution that can be adapted to all types of buildings and users. A sure investment to meet the needs of each of your projects.

General Specifications

Load	320 to 1,000 kg
Capacity	4 to 13 persons
Speed	1 - 1.6 m/s
Maximum Travel	50 - 60 m
Maximum Floors Served	16 - 21 floors
Machine-room Option	Yes
Entrances	1 Front 2 Open through 2 Front & side (<700kg)
Drive System	Regulated gearless (240 stars per hour)
Controller	ARCA III controller, low energy consumption multiprocessor
Door Types	Automatic side-opening Automatic centre-opening
Clear door opening	From 700 to 1,000 mm (at intervals of 100 mm)
Door Height	2,000 / 2,100 / 2,200 / 2,300 mm
Car Dimensions	Parametric
Internal Car Height	2,100 / 2,200 / 2,300 / 2,400 mm

1 Entrance

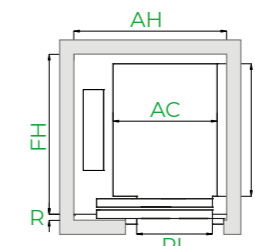

2 Entrances (open through)

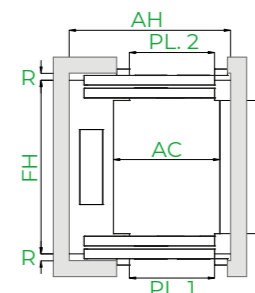

2 Entrances (front & side)

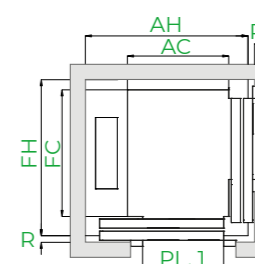

Vertical section

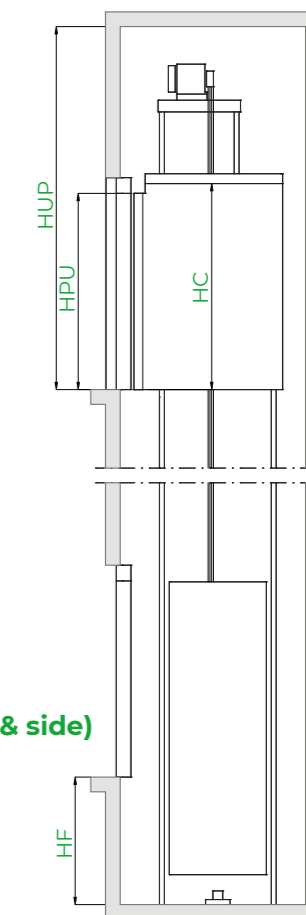

*Note: The diagrams are for guidance only. Dimensions for 1 entrance. Car width and depth variable, in 5 mm increments. For simplification, table samples show increments of 100 mm.

Customised solution, examples of dimensions*

Load / Capacity			Car (mm)			Entrances		Lift Shaft ⁰ (mm)				HF Pit	HUP ⁵ Headroom
Speed	Persons	Q Load	AC Width	FC Depth	PL Clear opening	Accessibility	No. of entrances	Two-panel side-opening doors		2-panel central-opening doors			
								AH ¹ Width	FH ² Depth	AH Width	FH ³ Depth		
1 m/s	4	320 kg	825	1,100	700	-	1 2x180°	1,300	1,350 1,500	-	-	1,000 (830) ⁴	3,400
	6	450 kg	1,000	1,250	800	♿	1 2x180°	1,450	1,500 1,650	1,725	1,450 1,550		
	8	630 kg	1,100	1,400	900	♿	1 2x180°	1,600	1,675 1,850	1,925	1,625 1,750		
	10	800 kg	1,350 ⁷	1,400	900		1 2x180°	1,825	1,675 1,850	1,925	1,625 1,750		
							1 2x90°	1,970	1,685 1,650	2,045	1,625 1,750		
	13	1,000 kg	1,600 ⁸	1,400 ⁸	1,000		♿	1 2x180°	2,075	1,675 1,850	2,150		
						1 2x90°		2,045	1,885	-	-		
						1 2x180°		1,775	2,375 2,550	2,125	2,300 2,400		
						1 2x90°		1,745	2,385	-	-		
	1.6 m/s	4	320 kg	825	1,100	700	-	1 2x180°	1,325	1,350 1,500	-		
6		450 kg	1,000	1,250	800	♿	1 2x180°	1,475	1,500 1,650	1,725	1,450 1,550		
8		630 kg	1,100	1,400	900	♿	1 2x180°	1,625	1,675 1,850	1,925	1,625 1,750		
10		800 kg	1,350	1,400	900		1 2x180°	1,850	1,675 1,850	1,925	1,625 1,750		
							1 2x180°	2,100	1,675 1,850	2,175	1,625 1,750		
13		1,000 kg	1,600	1,400	1,000		1 2x180°	2,100	1,675 1,850	2,175	1,625 1,750		
						1 2x180°	1,775	2,375 2,550	2,125	2,300 2,400			

0 Minimum plumb measurements

- 1 Accessible space below the pit (Counterweight with safety gear), add 115 mm to AH
- 2 R=60 mm, lift shaft depth with 2-panel side-opening doors, resting 60 mm on the landing
- 3 R=40 mm, lift shaft depth with 2-panel centre-opening doors, resting 40 mm
- 4 HF reduced pit optional 830 mm

5 Minimum HUP for internal car height (HC) of 2,100 mm

- 6 HUP optional reduced (HUP=HC+900). Consult availability of car dimensions
- 7 For 800 Kg to 90° AC 1,325 mm
- 8 For 1,000 Kg to 90° AC 1,400 mm FC 1,600 mm
- 9 For 1,000 Kg to 90° PL 900 mm

* The information is not contractually binding and is subject to the conditions of the shaft

Customised car dimensions

Car width										Car depth										
										Clear door opening										
								13	12	1,600										
								13	13	1,500										
								13	13	1,400										
								13	12	1,300										
								13	13	1,200										
								13	13	1,100										
								12	12	1,000										
								11	10	900										
								2,100	2,000	1,900	1,800	1,700	1,600	1,500	1,400	1,300	1,200	mm	800	900

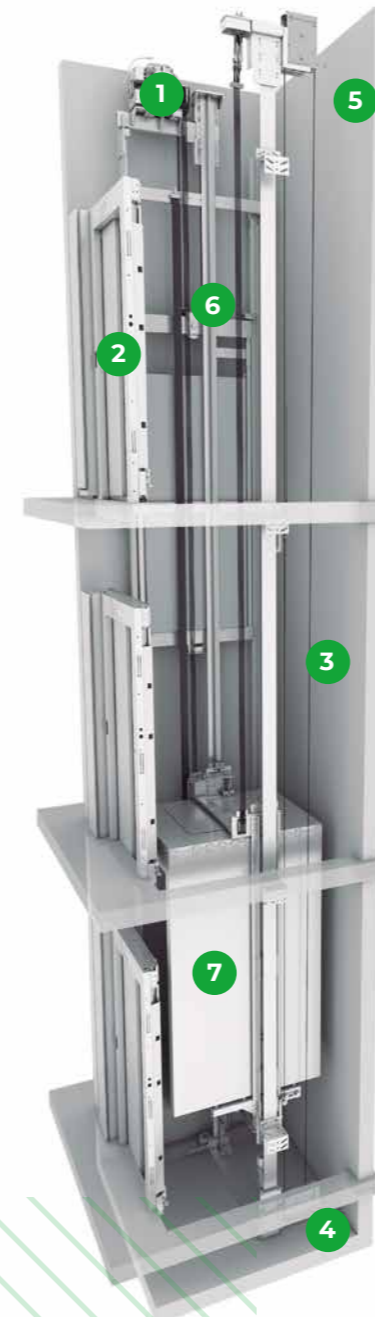

Drive
Compact, quiet, gearless, energy-efficient, inverter-drive permanent-magnet motor electrical machine.



Solid doors
Extra robust doors which improve sound-proofing inside and outside the lift and which are specially sized for an intense flow of people.



Parametric / Flexible
The parametric dimensions offer the possibility of adapting the lift to most potential space-based needs (optional).



Accessible space below the pit
Adapts the lift to suit buildings requiring an accessible space below the pit (optional).



Reduced headroom
Optional system that allows reducing the space required above the last floor in the building while ensuring maximum safety and protection for maintenance technicians.



Traction ropes
They replace traditional steel ropes. As a result of their lighter weight, longer lifespan and greater flexibility, it is possible to use a more compact machine with a more efficient and eco-friendly motor.

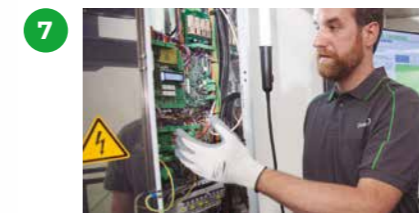

Automatic rescue system
With floor level indication to ensure fast, efficient and safe evacuation of passengers in the event of an emergency. As an option, the system can incorporate a fully-automatic rescue device to evacuate passengers in the event of a power failure.



Smart+ Features that can satisfy every need.

Quicker, stronger, taller. Reliability and durability in transport, guaranteeing the safety of all users.

General Specifications

Load	630 to 2,500 kg
Capacity	8 to 33 persons
Speed	1 - 1.6 m/s
Maximum Travel	50 - 75 m
Maximum Floors Served	32 floors
Machine-room Option	Yes
Entrances	1 Front 2 Open through 2 Front & side (<1,250kg)
Drive System	Regulated gearless (240 stars per hour)
Controller	ARCA III controller, low energy consumption multiprocessor
Door Types	Automatic side-opening Automatic centre-opening
Clear door opening	From 800 to 1,600 mm (in 100 mm increments)
Door Height	2,000 / 2,100 / 2,200 / 2,300 mm
Car Dimensions	Parametric
Internal Car Height	2,100 / 2,200 / 2,300 / 2,400 mm

Standard Optional

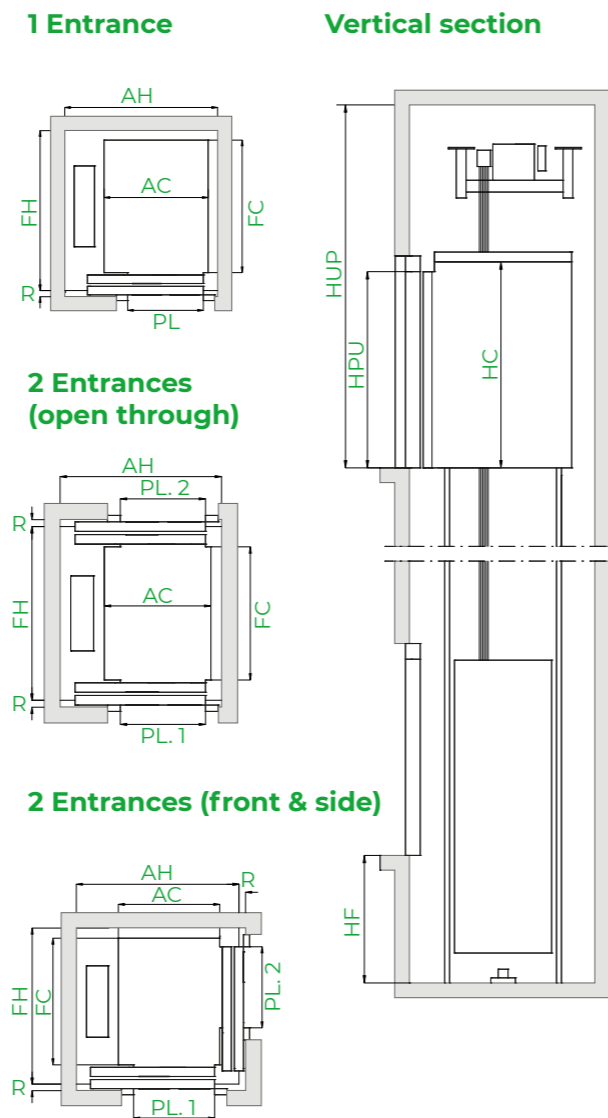

*Note: The diagrams are for guidance only. Dimensions for 1 entrance. Car width and depth variable, in 5 mm increments. For simplification, table samples show increments of 100 mm.

Customised solution, examples of dimensions*

Speed	Load / Capacity		Car (mm)			Lift Shaft° (mm)*							
	Persons	Q Load	AC Width	FC Depth	PL Clear opening	Side-opening doors				Centre-opening doors			
						Entrance		AH ¹ Width	FH ² Depth	AH Width	FH ³ Depth	HF Pit	HUP Head-room
1 m/s	8	630 kg	1,100	1,400	900	1	2x180°	1,700	1,675	1,950	1,625	1,050	3,550
	10	800 kg	1,350	1,400	900	1	2x180°	1,975	1,675	1,975	1,625		
												2	2x180°
	13	1,000 kg	1,600	1,400	1,000	1	2x180°	2,225	1,675	2,225	1,625		
												2	2x180°
	17	1,275 kg	1,200	2,300	1,100	1	2x180°	1,775	2,375	-	-		
												2	2x180°
	21	1,600 kg	1,700	1,950	1,000	1	2x180°	1,935	2,600	-	-		
												2	2x180°
24	1,800 kg	2,350	1,600	1,200	1	2x180°	-	-	2,450	2,200	1,150		
												2	2x180°
26	2,000 kg	2,350	1,700	1,200	1	2x180°	-	-	3,150	1,950	1,465		
												2	2x180°
33	2,500 kg	1,800	2,700	1,300	1	2x180°	2,600	3,050	-	-			
											2	2x180°	2,600
1.6 m/s	8	630 kg	1,100	1,400	900	1	2x180°	1,725	1,675	1,950			
											2	2x180°	1,725
	10	800 kg	1,350	1,400	900	1	2x180°	1,975	1,675	1,975			
											2	2x180°	1,975
	13	1,000 kg	1,600	1,400	1,000	1	2x180°	2,225	1,675	2,225			
											2	2x180°	2,225
	17	1,275 kg	1,200	2,300	1,100	1	2x180°	1,775	2,375	-			
											2	2x180°	1,775
	21	1,600 kg	1,700	1,950	1,000	1	2x180°	1,935	2,600	-			
											2	2x180°	1,935
24	1,800 kg	2,350	1,600	1,200	1	2x180°	-	-	2,450	2,200			
											2	2x180°	2,085
26	2,000 kg	2,350	1,700	1,200	1	2x180°	-	-	3,150	2,050			
											2	2x180°	2,300
33	2,500 kg	1,800	2,700	1,300	1	2x180°	2,600	3,050	-	-			
											2	2x180°	2,600

- 0 Minimum plumb measurements
- 1 Accessible space below the pit (Counterweight with safety gear) add 50 mm to AH
- 2 Shaft depth with door tracks projecting 60 mm on the landing
- 3 Shaft depth with door tracks projecting 40 mm on the landing
- 4 Minimum HUP for internal car height (HC) of 2,100 mm

* The information is not contractually binding and is subject to the conditions of the shaft

Flex Fits in any shaft.

Finite space, infinite solutions

General Specifications

Load	180 to 630 kg 180 to 450 kg (Single-phase)
Capacity	2 to 8 persons 2 to 6 persons (Single-phase)
Capacity	1 m/s / 0.6 m/s (Single-phase)
Maximum Travel	40 m / 25 m (Single-phase)
Maximum Floors Served	14 Floors
Machine-room Option	Yes
Entrances	1 Front 2 Open through 2 Front & side
Drive System	Regulated gearless (180 stars per hour)
Controller	ARCA III controller, low energy consumption multiprocessor
Door Types	Automatic side-opening / Automatic centre-opening / Semiautomatic + Articulated (BUS)
Clear door opening	From 500 to 900 mm
Door Height	2,000 / 2,100 / 2,200 mm
Car Dimensions	Parametric
Internal Car Height	2,100 / 2,300 mm

1 Entrance

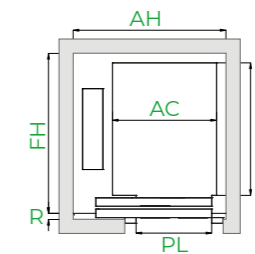

2 Entrances (open through)

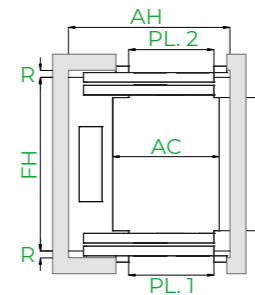

2 Entrances (front & side)

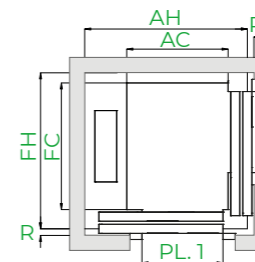

Vertical section

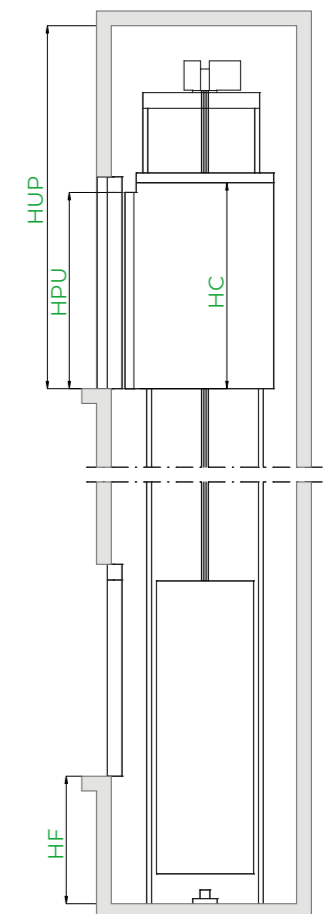

1 Drive
Compact, quiet, gearless, energy-efficient, inverter-drive permanent-magnet motor electrical machine.
✔️🌱



2 Machine room
Simplifies lift maintenance operations thanks to the space available in the room.
✔️



3 Robust lift car
Provides greater lift comfort, reducing vibration and noise during lift travel.
✔️



4 Accessible space below the pit
Adapts the lift to suit buildings requiring an accessible space below the pit (optional).
📄✔️



5 Travel time
Special solution for buildings with long travel times.
📄

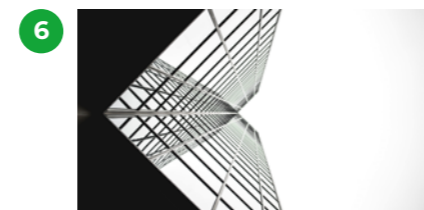

6 Speed
Solution that reaches a greater speed, offering quicker trips for long travel times.
📄



7 Cars
Special car dimensions, with extra depth and wider doors. Designed with reinforced panels and floors for multiple and intensive uses.
♿️



8 Automatic rescue system
With floor level indication to ensure fast, efficient and safe evacuation of passengers in the event of an emergency. As an option, the system can incorporate a fully-automatic rescue device to evacuate passengers in the event of a power failure.
♿️✔️

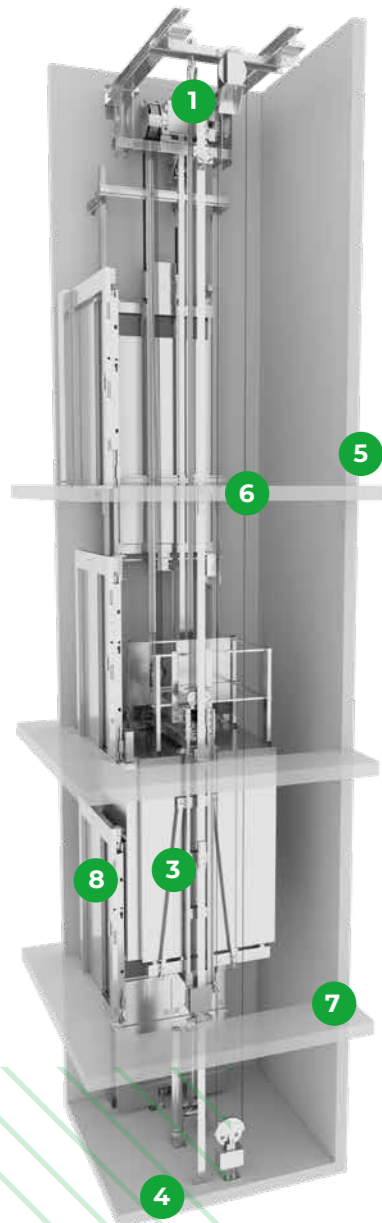

*Note: The diagrams are for guidance only.

Options

	Next Essentia	Next Smart	Next Smart+	Next Rise	Next Flex
Eco-efficiency					
Low-energy drive	●	●	●	●	●
Efficient LED lighting	●	●	●	●	●
Automatic car lighting switch off	●	●	●	●	●
Landing illumination control	○	○	○	○	○
Lift stand-by mode	○	○	○	○	○
Adaptability					
Flexible controller location	○	○	○	○	○
Lift well enclosure	○	○	○	○	○
Reduced headroom (with safety space)	○	○			
Reduced pit (with safety space)	○	○			○
Accessible space below the pit	○	○	○	○	○
Single-phase supply	○				○
Control and safety					
Evacuation					
Autodialler system	●	●	●	●	●
Automatic rescue system	○	○	○	○	○
Behaviour of lifts in the event of fire (EN 81-73)	○	○	○	○	○
Connection to auxiliary power source (generator)	○	○	○	○	○
Pit water detector	○	○	○	○	○
Safety landing call cancelling	○	○	○	○	○
Firefighters lift (EN 81-72)		○	○ (>1,000kg)	○	
Access control					
Zone cancelling, coded call	○	○	○	○	○
Compulsory stop at main floor	○	○	○	○	○
External call cancelling	○	○	○	○	○
Automatic car call deletion	○	○	○	○	○
Independent entrance selection	○	○	○	○	○
Non-emergency outage	○	○	○	○	○
Emergency outage	○	○	○	○	○
Anti-vandalism (EN 81-71)		○	○	○	
Communications					
Pre-opening doors	○	○	○	○	○
Down collective control	○	○	○	○	○
Full collective control	○	○	○	○	○
Intercom system	○	○	○	○	○

Design your own space, because first impressions count.

Quality involves fighting time to maintain the aesthetics and functionality of the lift for as long as possible. And the only way to respond to this challenge is through smart design and excellent quality materials. When a person enters our lifts, this condition must be present throughout their trip, which is why Orona offers different ambiances. All good things last longer.

HARMONIA

Ambiances inspired by natural elements, transmitting peace and serenity.



INNOVA

Innovation applied to design, offering refreshing trips that are full of energy.

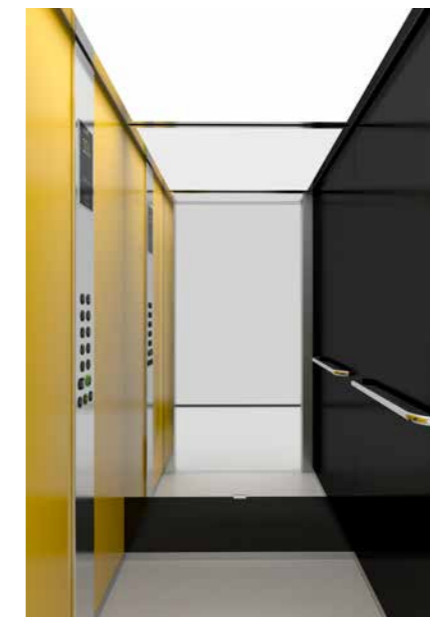

RINACCIA

Ambiances based on timeless elements of contemporary architecture, offering an elegant experience.

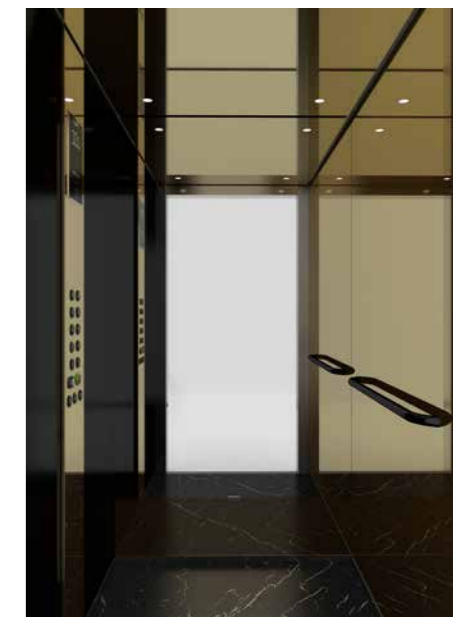

* In order to validate these options please consult with us.

● Standard ○ Optional

ORONA